

Specification Datasheet

COMPACT AC AXIAL FAN (COOLING FAN)

Model Number	: RC-17255B1HSL
Fan Size	: 172x172x55MM
Bearing System	: Ball Bearing
Blade	: PBT (5 Blade)
Housing	: Aluminium Die Cast
Motor Protection	: Shaded Pole Motor
Operating Temperature	: -25°C to +70°C
Insulation Class	: B
Insulation Resistance	: ≥100MΩDC 500V Megger
Operating Voltage	: 110~115VAC
Current Ampere	: 0.40/0.45
Watt	: 29/34
Frequency (Hz)	: 50/60
Speed (RPM)	: 2650/2750
Air Flow (CFM)	: 175/220
Noise (dBA)	: 48/53
Product Life	: 25~40K Hours 25-40°C
High Voltage Test	: 4kV 50Hz Withstood

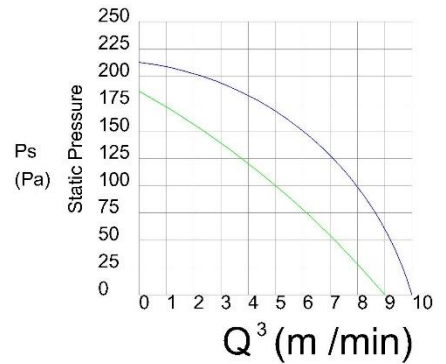

Air Flow

FAN DIMENSIONS IN MM

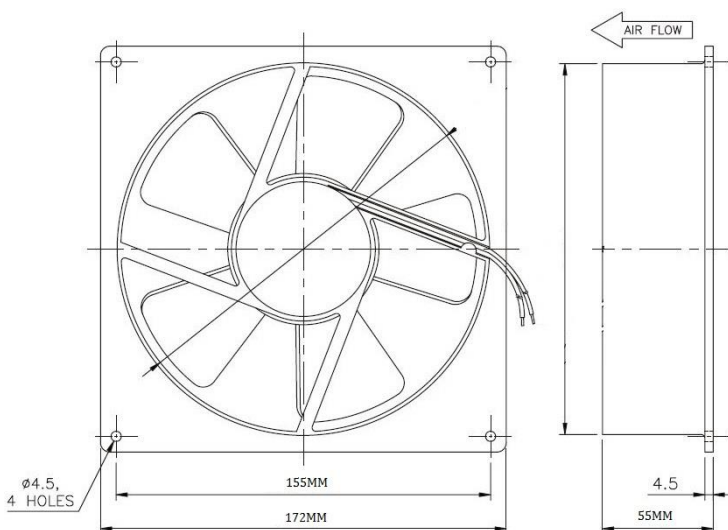

PANEL CUTOUT

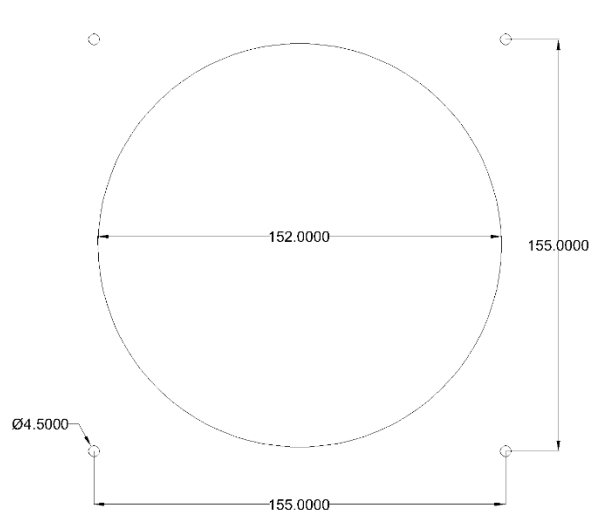

VALAKI INDUSTRIES

866/6/5-A, MAKARPURA GIDC, GUJARAT, INDIA.

valakiindustries@gmail.com